

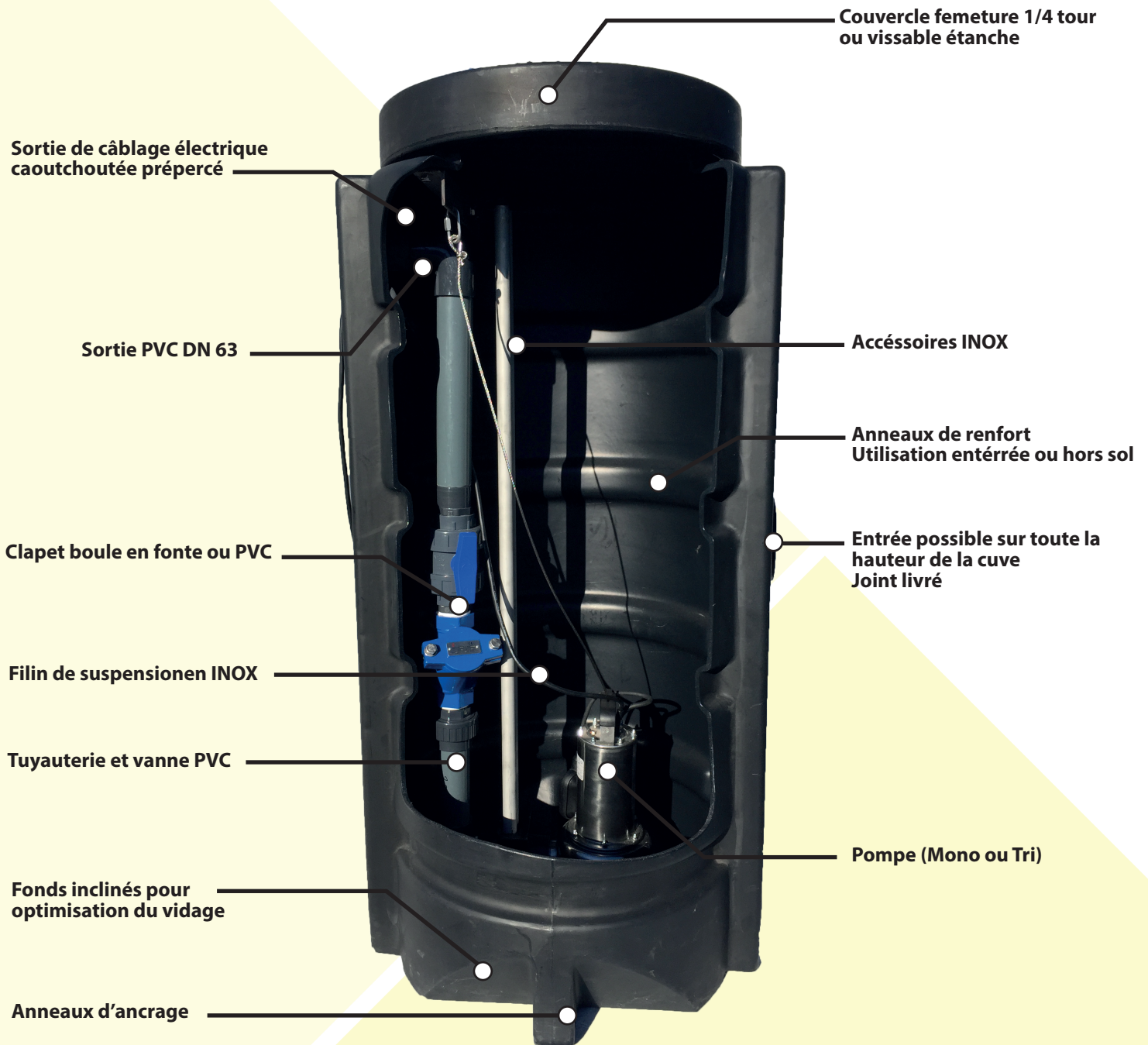

POSTE DE RELEVAGE

PR3 - PR6 - PR9



LES OPTIONS

- Panier degriilleur (uniquement pour PR9)
- Rehausse de cuve:
 - .PR6 = 400mm
 - .PR9 = 500mm
- Coffret électrique pour pompe mono TR50MS et TR65MS
- Coffret électrique pour pompe tri
- Coffret d'alarme avec flotteur
- Sonde PIEZO

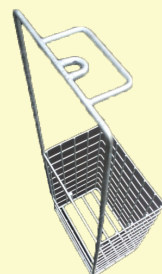

PANIER DEGRILLEUR
en option



POSTE DE RELEVAGE

PR3 - PR6 - PR9

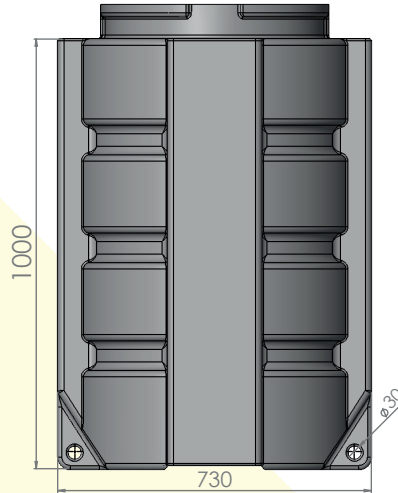
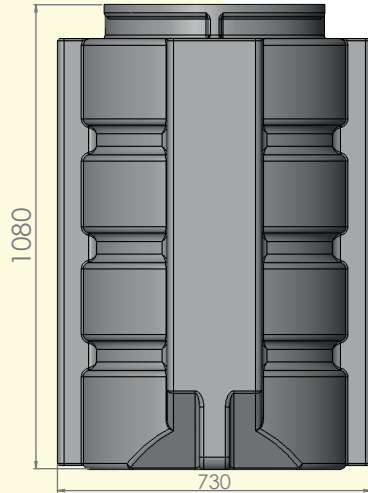

PR6/1000
340 litres enterrable
Poids 24 Kg (cuve nue)

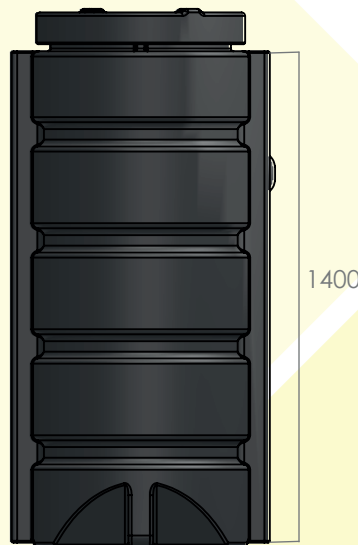
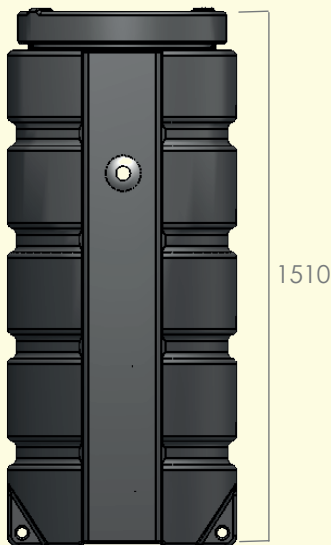
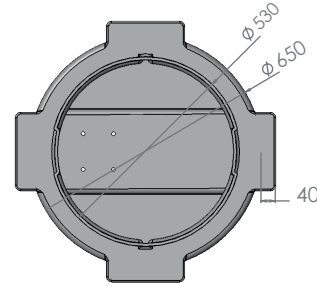

PR6/1500
440 litres enterrable
Poids 40 Kg (cuve nue)

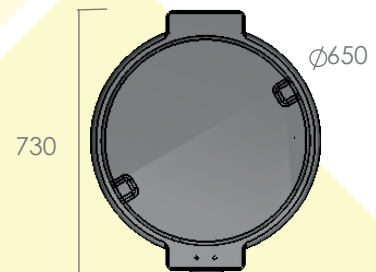

Type de pompe	PR3	PR6/1000	PR6/1500	PR9/1500	PR9/2000	
TR eco	1					eau claire
TD 40	1					
TR 35 M	1	1	1	1	1	eau + WC assainissement non collectif
TR 50 M	1	1	1	1	1	
TR 50 MS		1	1	1 ou 2	1 ou 2	eau + WC collectivités restaurant ...
TR 50 T		1	1	1 ou 2	1 ou 2	
TR 65 T TR 65 MS				1 ou 2	1 ou 2	

Nbr de pompe Pompe sur pied raccordée par un tuyau souple
 Pompe sur pied d'assise double barres de guidage



POSTE DE RELEVAGE

PR3 - PR6 - PR9

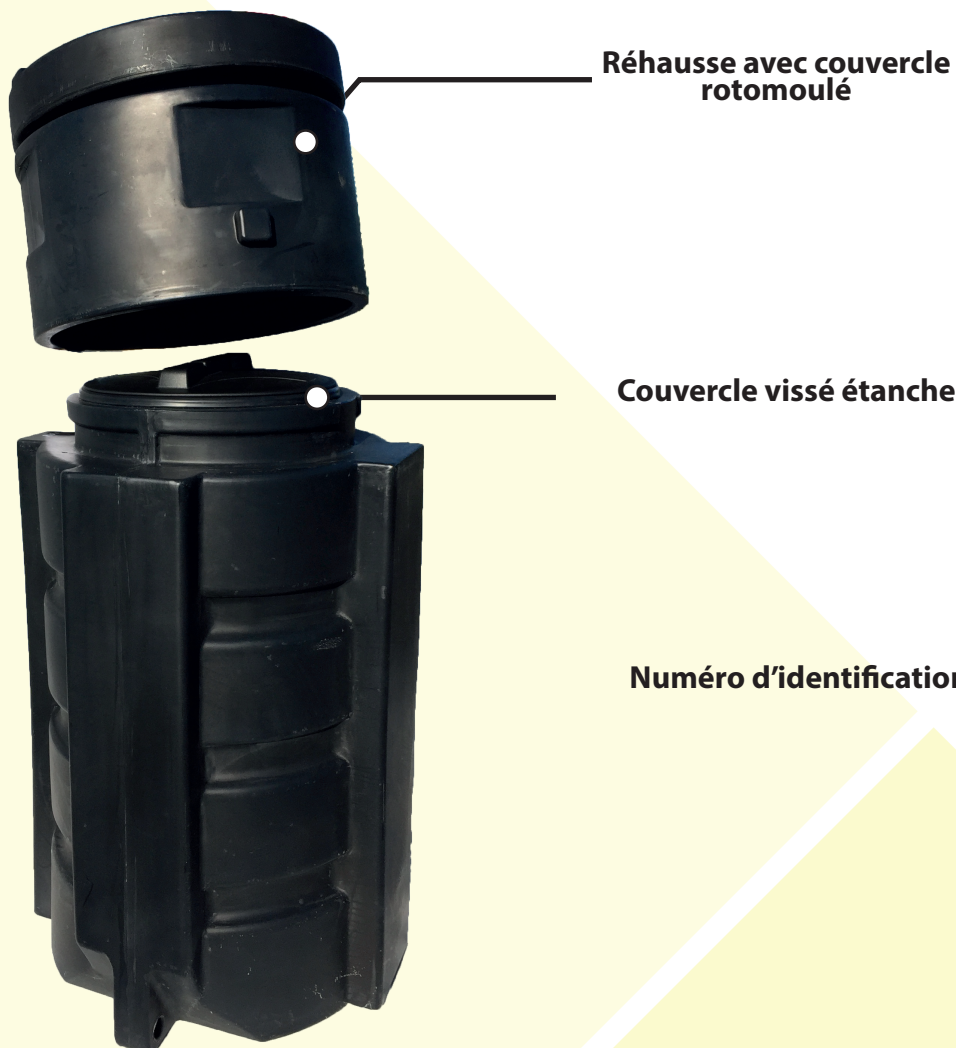

Eau claire

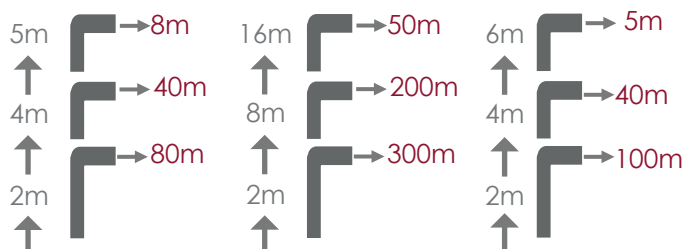

TR ECO



TD 40



TR 35M

Eau + WC Assainissement non collectif

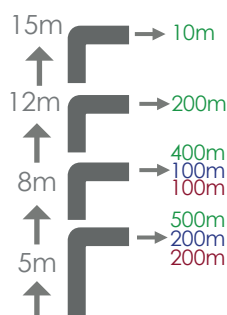

TR 50M ou TRF-SV32mg
TR 50MS
TR 50T

Eau + WC Collectivités

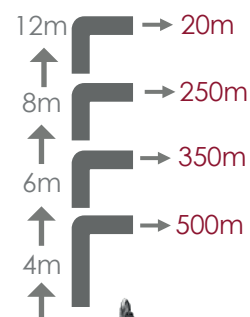

TRF-PV65-2/220T



POSTE DE RELEVAGE

PR3 - PR6 - PR9

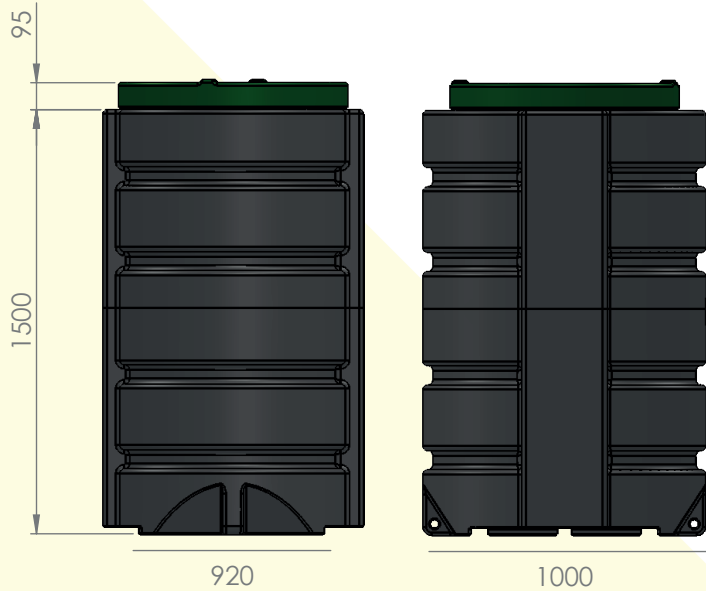

PR9/1500
800 litres enterrable
Poids 53 Kg (cuve nue)

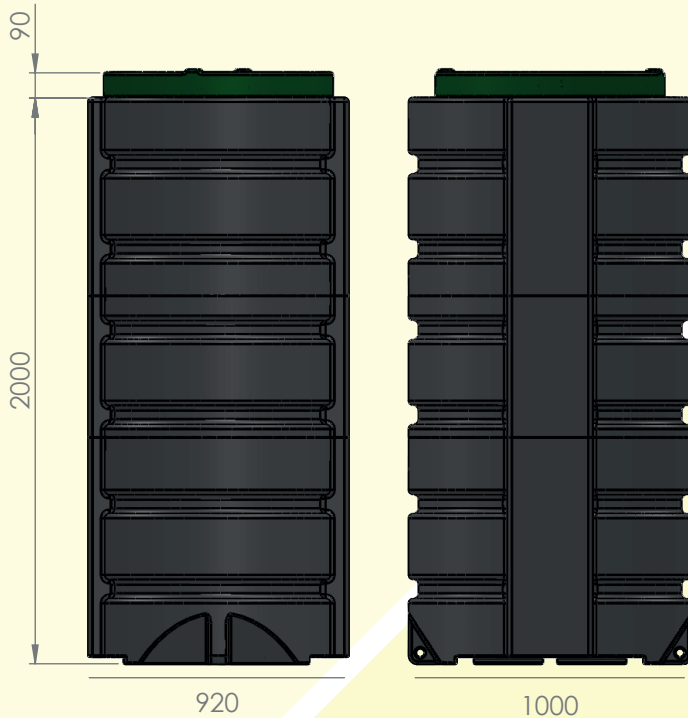

PR9/2000
1200 litres enterrable
Poids 68 Kg (cuve nue)

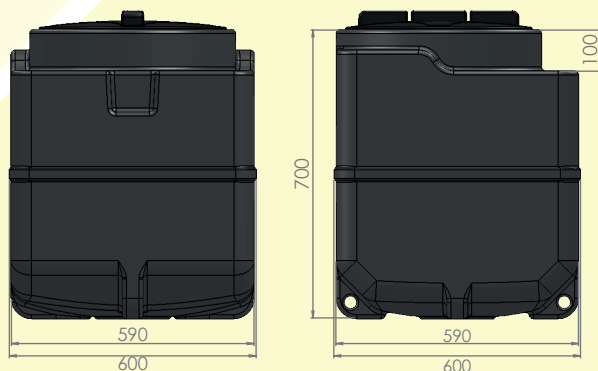

PR3
200 litres hors sol
Poid 15 Kg (cuve nue)